



Billy Oh Rosette Green House – Assembly Hints and Tips



WARNING

Please refer to all safety notices in the greenhouse manual before assembling any of the sections

TOP TIPS

1. These instructions are generic for all models. Part numbers vary, please use this product in accordance with your supplied instruction manual.
2. Please check you have the correct instructions. All parts should be labelled as follows:
Part **A** for the 12 x 8 greenhouse, Part **B** for the 10 x 8 greenhouse,
Part **C** for the 7.4 x 7.4 greenhouse, Part **D** for the 8 x 6 greenhouse.
3. To ensure the base is level and square, the use of a spirit level is essential and diagonal corner measurements must be taken and accurately correspond. Failure to achieve this will result in the greenhouse frame being out of line and prevent accurate positioning of the glazing panels.
4. When satisfied with the base section the frame should be erected with constant use of the spirit level even though adjustments will be necessary as the work progresses.



5. When assembling the greenhouse assemble the screws and nuts lightly, once you are happy with the construction these can be tightened completely. Do not over tighten.
6. On completion of the framework and before beginning the glazing, it is advisable to test the square of each of the roof sections with one of the panels and likewise the side and other sections.
7. When placing roof sections into the ridge make sure they are pushed as far up as possible into the ridge section.
8. Ensure tape is used when commencing the glazing procedure. Without it the bottom of panels will be vulnerable to high winds since the securing clips only attach to the sides of the frame. Use tape at the top and bottom of the panel as a minimum guideline.
9. It may be necessary to nip the top corners of the roof panels with pliers to slip more easily into the grooves, take care not to damage the panels as this would not be covered under warranty.
10. The piece of tape for the top of the panels may be better fixed from inside the greenhouse as the recess is tight.
11. If the greenhouse is sited in an exposed location and/or is exposed to high winds, improvisation for extra protection may be considered. If so the following is recommended:
Drill 3 holes in the ridge section central to each of the roof panels. Then drill 3 corresponding holes in both gutters. Fix strong cord (i.e. Clothes line) through the holes and make fast to further safeguard the roof panels. Give similar attention to the side and rear panels. This time attach 2 cords horizontally and equally spaced. It is important to drill the holes in the uprights as close as possible to the face of the panels. If these guidelines are followed diligently, the panels cannot escape even if the clips are dislodged by gale force conditions. (Please note this is a tip provided by a customer to provide additional protection during strong winds. It is not guaranteed to prevent damage occurring during adverse weather but merely a suggestion). (see Additional Customer Tips section)
12. To summarise, the erection of the BillyOh Rosette Greenhouse may in the beginning appear a daunting task and the structure deceptively flimsy. However, with patience and perseverance, the end result is worth all efforts and the finished article , remarkably resilient.



Base Frame Assembly

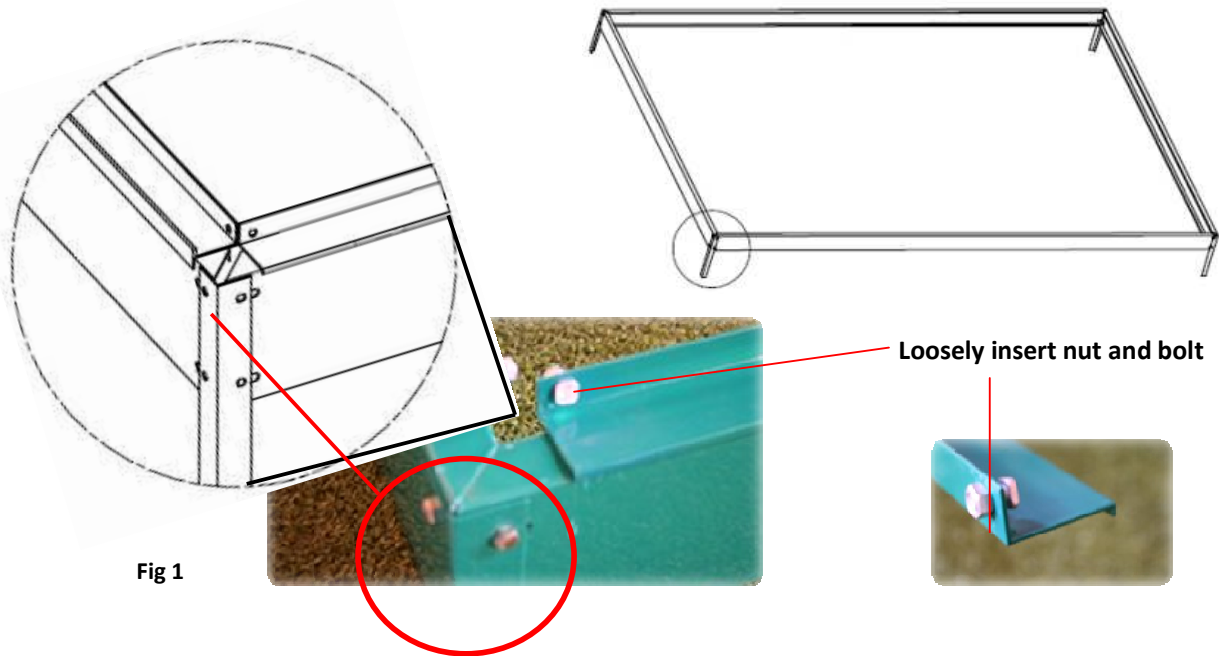
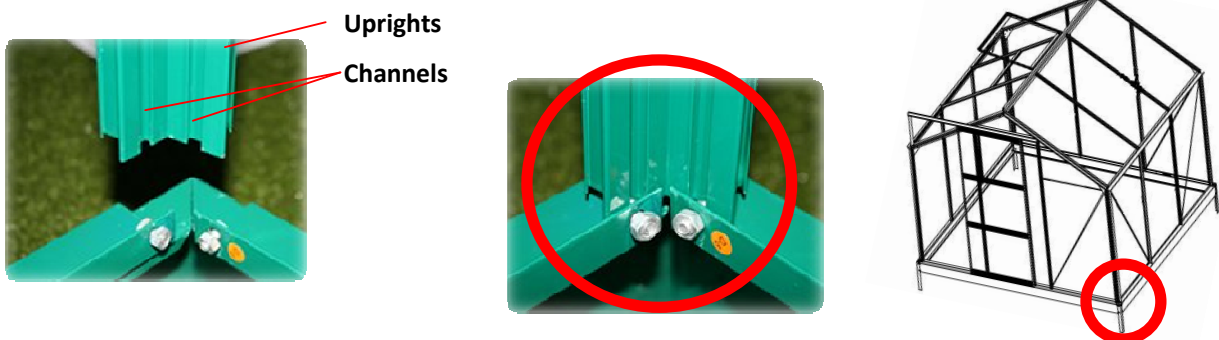

Fig 1

Assemble the base frame as detailed in the instructions and secure using the bolts as above. Place the nut and bolts into the top sections and secure loosely then lay the next sections on top of the base as per Fig 1.

Corner Uprights

Offer the upright corner section to the base and slot the nut heads into the groove on the upright, do this carefully. Once the nut heads are in the channel and the upright is in place the nuts and bolts can be tightened. Do not over tighten.





Clips for Uprights

Each of the uprights has clips (Part 35) on the inside which need to be used as shown to add additional stability to the uprights.

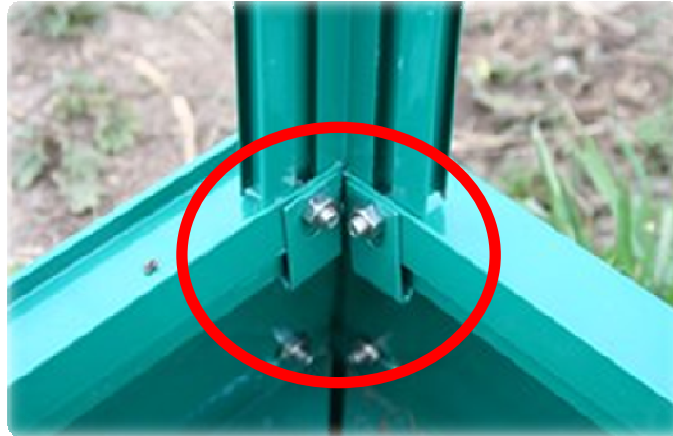

Note how the corner is completed. The photo is taken inside the greenhouse and we are looking at the Right hand corner. Insert triangle shaped piece before adding supports.

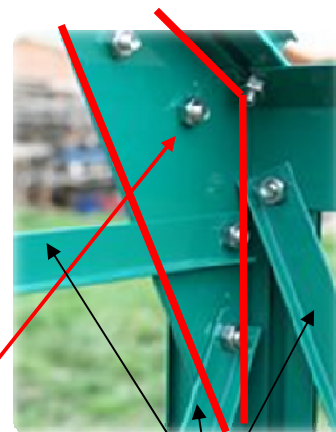
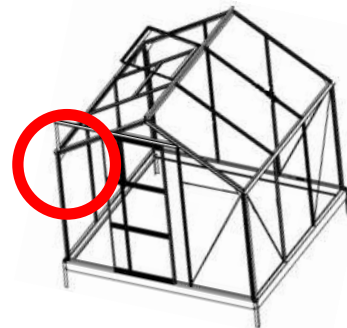

Triangle Piece

Supports



Door Runner Assembly

It is recommended to leave the fitting of the door runner (Part #22)until the rest of the greenhouse is complete. As a first stage when building the main green house just place the nut and bolt in place on the left and right side as per the following photo. These are the bolts that the runner (part 22) slides onto at a later stage.

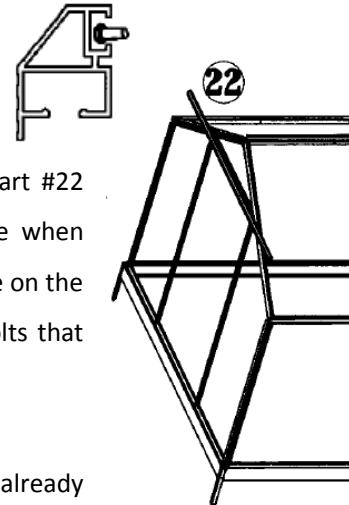

When you are ready to place the already assembled doors onto the frame please take note of the following which is for the right hand door.

Slide the runner over the left hand bolt towards the right hand bolt.



Then slide the first top door runner into the groove



Push the door runner further to the right and attach the bolt into the groove and continue to push the runner over to complete the fitting.





Place the remaining top door runner into the groove to complete the door attachment process. Make sure you attach the bottom grooves to the greenhouse base.



Once you have the runner in place with the doors, the last job to do is to tighten the two top bolts.



Door Runner Corner Assembly

At first glance it appears from the instructions that the fitting of the door rail assembly is complicated because the door rail sits further forward than the frame. To overcome this two L shaped clips are used in conjunction with each other which allows the door frame runner to be connected to the main greenhouse frame. This is achieved as follows, place one L shape piece onto the frame and use the nut and bolts to secure then place the second L shaped piece on top of the first one and bolt the two together, the second one can then be bolted to the door frame runner.

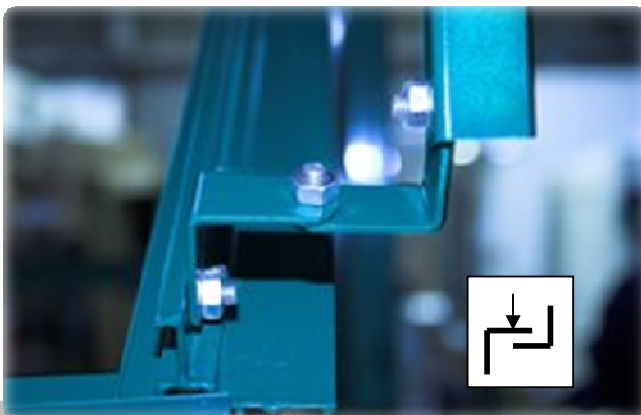

Front View



Rear View



Down Pipe Collector

The plastic down pipe connector slides between the gutter and the upright. Tip, you may need to loosen the nut and bolts to assist in this then push the plastic connector in and re-tighten the bolts.





Opening Vent

Some greenhouses have one opening vent and the larger units have two. The assembly of them is exactly the same. Assemble the frame of the opening vent as per the instructions.

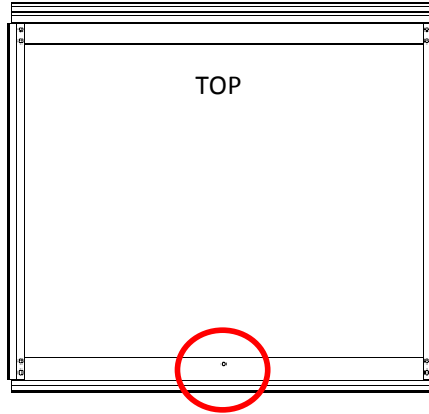

Note the hole in the centre of the bottom section, this is for the opening vent handle.

Once the frame is assembled this needs to be slid into the ridge frame of the greenhouse. There is a rounded top on the top edge of the opening vent and this needs to be slid into the opening on the ridge. You may need to hold the opening vent at a sharp angle to allow this. Trial and error will show you the correct method. Once in place slide the frame into position.

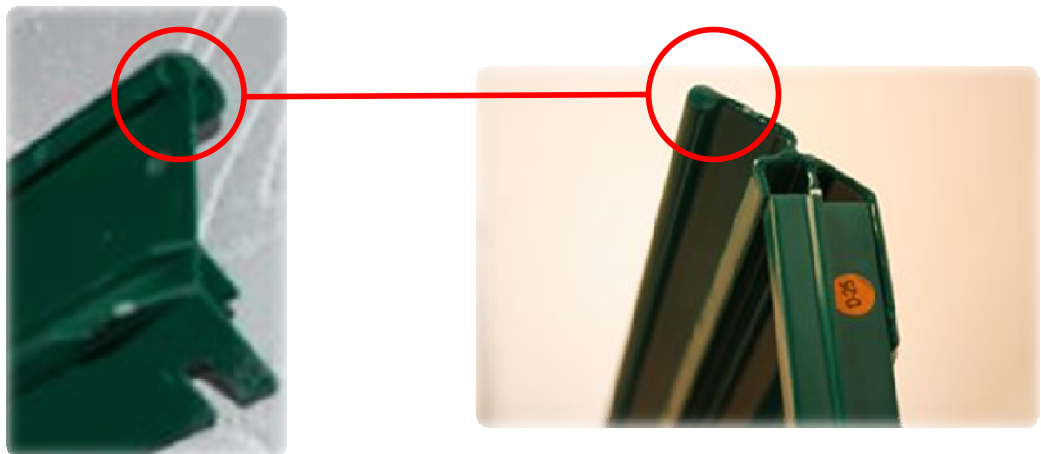



Please note that there will be gap at the top of the opening vent. This is normal and as it was designed to aid the opening of the window.

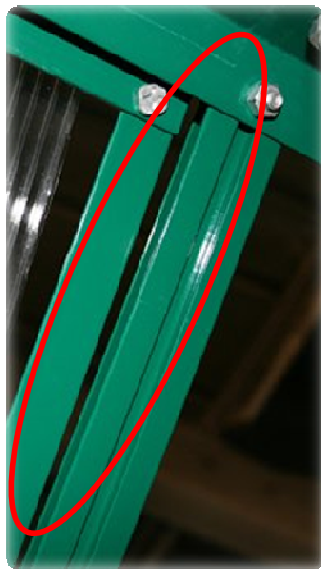

View from Inside

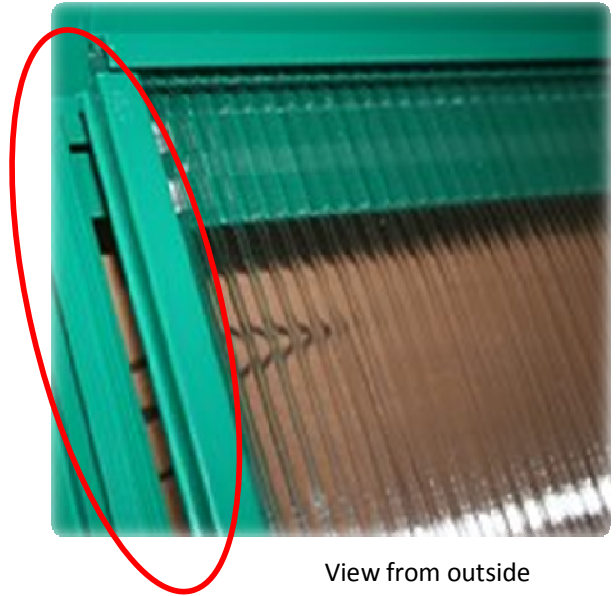

View from outside



Tip for opening vent. If the vent falls through once it is installed, undue the nuts slightly on the coss section and move up slightly until the bottom of the opening vent catches the centre cross member to prevent the opening vent from falling through into the greenhouse.

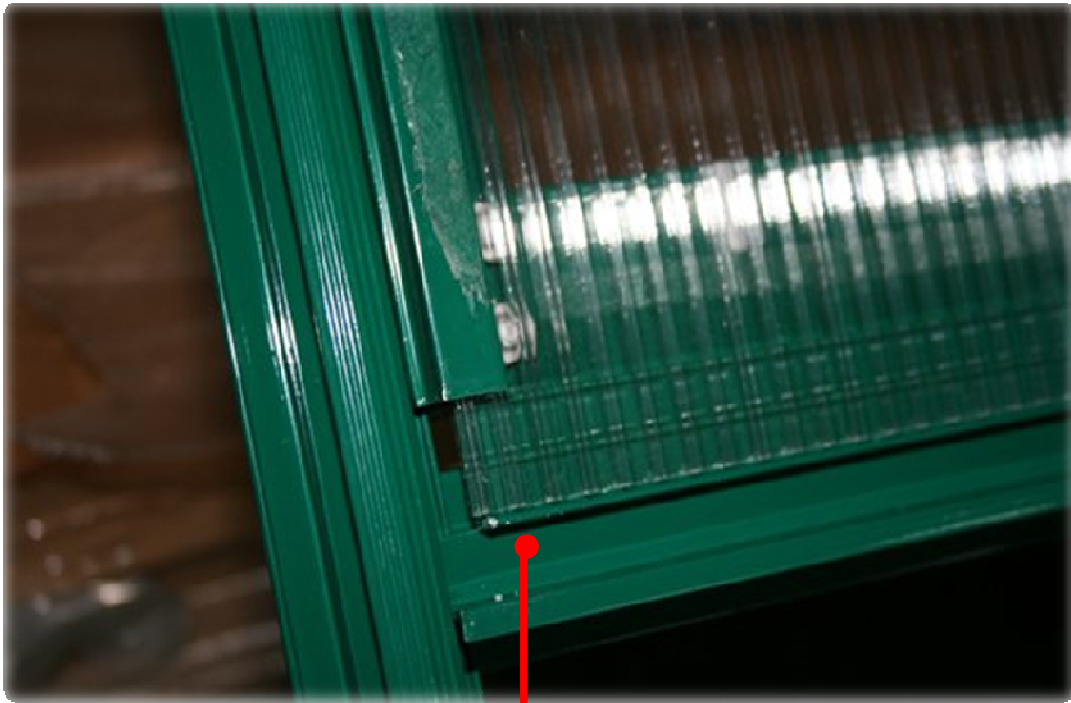

Cross Member which can be moved into position once the opening vent has been installed

Please make sure the cross member is correctly situated.

From the inside the grooves should be at the top. This allows for the positioning of the window stay when the window is open.





Door Frame Assembly – All Models

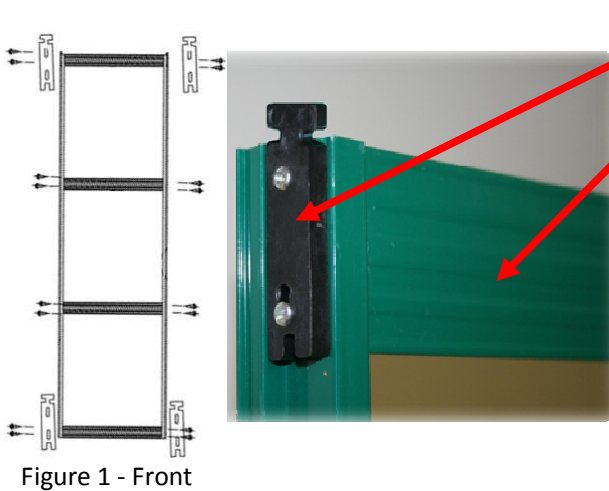

Plastic Runner for **TOP** of door Frame
Cross Member

Please note it is advisable to build the door frame starting from the top, place the cross member between the two door frame edges and secure using the plastic runners and the securing screws. (figure 1&2) Do not tighten until the plastic runner is in the correct place. This will move up and down as required.



Figure 2 - Rear

Note how the cross members are slotted into the frame edge (figure 3). Please make sure that the plastic runners are placed the correct way around for the top of the frame and the bottom of the frame. (**T** shape for top and **U** shape for the bottom) Once the cross member is secure at the top of the frame place the glazing in the frame and then place the next cross member between the two frame edges and secure with the screws provided (figure 4). Please note the correct fitting for the bottom plastic runner. (figure 5).





Figure 3 – Rear of Door



Figure 4 – Door Front



Figure 5 – Bottom of Door



Please see figure 6 which shows how door is placed into the upper door frame.

Figure 6



Additional Tips Supplied by our Customers

(for information Only)

1. If the greenhouse is sited in an exposed location and/or is exposed to high winds, improvisation for extra protection may be considered. If so the following is recommended:
 Drill 3 holes in the ridge section central to each of the roof panels. Then drill 3 corresponding holes in both gutters. Fix strong cord (i.e. Clothes line) through the holes and make fast to further safeguard the roof panels. Give similar attention to the side and rear panels. This time attach 2 cords horizontally and equally spaced. It is important to drill the holes in the uprights as close as possible to the face of the panels. If these guidelines are followed diligently, the panels cannot escape even if the clips are dislodged by gale force conditions. (Please note this is a tip provided by a customer to provide additional protection during strong winds. It is not guaranteed to prevent damage occurring during adverse weather but merely a suggestion).



Customer Tip provided by Mr K Baldock www.brushclub.com

